



# Welcome to Town Hall

Please be patient as we give  
time for people to log in.  
Go ahead and say where  
you're tuning in from and  
how many years you've been  
**SOAKing** in chat!

**Much Love from Warm Snuggles Camp!**

(fyi select 'everyone' as chat recipient)

**Burning Man Portland & Precipitation NW present**



**2023 TOWN HALL MEETING**

**2:00 - 5:00pm | 11th February 2023 | Zoom**

# 2023 Agenda

- 2:10ish Welcome & Webinar tips
- 2:15 - 3:0x SOAK\*2023
- 3:0x - 3:xx BurnOut
- 3:xx - 3:yy Safety NW
- 3:yy - 3:☞☞ Stretch break
- 3:☞☞ - 4:☞∞ Art Provisioning
- 4:☞∞ - 4:£™ Precipitation NW
- 4:£™ - 4:Δf Portland Regional Contacts
- 4:Δf - ^:Σβ Ways to get involved before event!

# Webinar Tips

Big appreciations to Devin from the Internet for helping out

## Chat

- For casual conversation
- Be civil and inclusive
- May default to 'Host/Panelist'.

## Q&A

- ● ● For asking questions to presenters
- May be answered by mod or read aloud and answered by producer



# SOAK 2022



*Whoops, we did it again!  
Thanks to everyone who helped make SOAK 2022 a success!*



# SOAK\*2023 Summer Camp

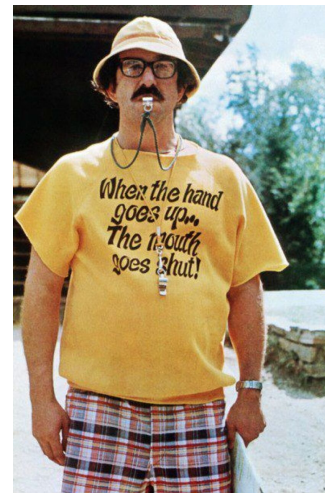



SOAK\*2023

SUMMER CAMP

MAY 25-29  
TYGH VALLEY, OR

# Outgoing Leads



Print: The Serious  
Box Office: Silver Dragon  
Ranger: Hazelnut  
Placement: Papa Bear, Joshy  
Gate: Spraypaint  
Fire Safety: Battalion 4  
DPW: Tight Pants, Eagle Eye  
Sanctuary: Squirtle & Little Cat  
VoHo: Fractal





# Returning Leads

Pathlighters: Naughty

VoHo: Mama Jean

VoCo: Maya

Ice: Arizona

PnC: Not-A-Cop

Anholt

Red Wizard

Fire Conclave: Sabrina

Art Provisions: Sepia



Placement: Redirect  
Bratty Cat  
Poppins

LNT: Pipie

Gate: Otter

DPW: Cupcake  
Pinky

Rangers: Goldilox

MBS: Cheshire

Sour Patch

Parking: Coco

# Incoming Leads

Placement: Mishi, Doggo, Cat Lady

Box Office: Chew Toy, Pablovex

Swag (ex-Print): Bubble, Snacks

LNT: Sarah

Gate: Hybrid

Census: Amanda

DPW: Ratchet

Fire Safety: Common Deer

Rangers: Likewise

MBS: Birthday Girl, Back Tuck

Parking: Turtle, Big Red

Pathlighters: Tightwad

VoCo: Sour Patch



# SOAK\*2023 Production Team

## Producers

Vibes

Rye

## Directors

NotSorry

Squirtle (Juliana)

Skeptical (JJ)

@pparatus



## Emeritus

HugBoss

Pablovex

GoldDust

Honeybee

OneEye

## Producers

PRODUCER	PRODUCER
Rye	Jordan

## Precipitation Northwest

## Regional

BARN MANAGER	REGIONAL CONTACT
Samuel	Porn★Star

### Infrastructure

DIRECTOR
Skeptical
PLACEMENT/ART
Redirect Poppins Bratty Cat Doggo Cat Lady Mishi
ART PROVISIONS
Sepia
LNT
Pipie Sarah
DPW
Cupcake Pinky Ratchet
PATHLIGHTERS
Naughty Tightwad

### Safety

DIRECTOR
@pparatus
FIRE
Common Deer
FIRE CONCLAVE
Sabrina
MBS
Cheshire Back Tuck Birthday Girl
POWER & COMMS
Not-A-Cop Anholt Red Wizard
RANGERS
Goldilox Likewise

### Services

DIRECTOR
NotSorry
VOHO
Mama Jean
ICE
Arizona
CENSUS
Amanda
SWAG & DESIGN
Bubble Snacks
VOCO
Maya Sour Patch

### Entry/Culture

DIRECTOR
Squirtle
BOX OFFICE
Pablovex Chew Toy
GATE
Otter Hybrid
PARKING
Coco Big Red Turtle
AMBASSADORS
Mega Vic

# SOAK\*2023 Org Chart

# SOAK Mailing List

- [SOAKpdx.com/newsletter](https://soakpdx.com/newsletter)
- All important information
- Less reliance on Facebook



SOAK Telegram!



SOAK Blog!



SOAK Newsletter!

A decorative graphic featuring a large, light blue dashed circle that curves around the central text. Various solid-colored circles in shades of teal, green, yellow, orange, and pink are scattered around the page, some overlapping the dashed line. A large teal ring is in the top left, a yellow ring is in the bottom right, and a green ring with a white center is in the bottom left.

MBS 2023  
Summer  
Camp

A decorative graphic consisting of a large, light blue dashed circle that frames the central text. Various colored circles (solid and hollow) in shades of teal, yellow, green, and orange are scattered around the perimeter of the dashed circle.

Hello!

**MBS Leads - Cheshire, Birthday Girl,  
BackTuck, and Sour Patch**

**2023 Artists - Becca/Jean, Marissa, Michael  
, Birthday Girl**

A decorative graphic featuring a large, light blue dashed circle that frames the central text. Various colored circles and rings are scattered around the page: a large lime green circle at the top left, a teal ring at the top center, a yellow circle at the top right, an orange circle at the bottom left, and a yellow circle at the bottom right. Smaller circles in green, blue, orange, and pink are also present.

“

What better to way to enjoy  
Summer Camp, than next to a  
warm fire with your friends.  
This year we combine ideas such as  
Camp Fire, Bonfire, Flame to create  
the ultimate MBS.



# The Concept

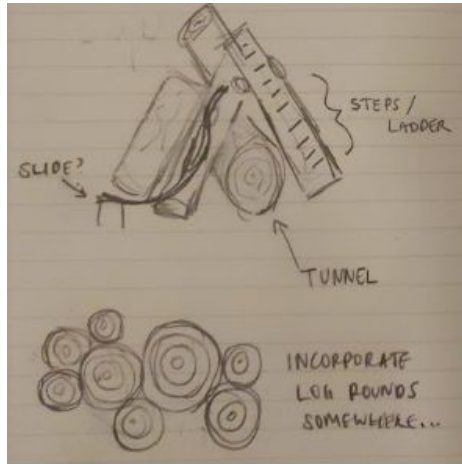

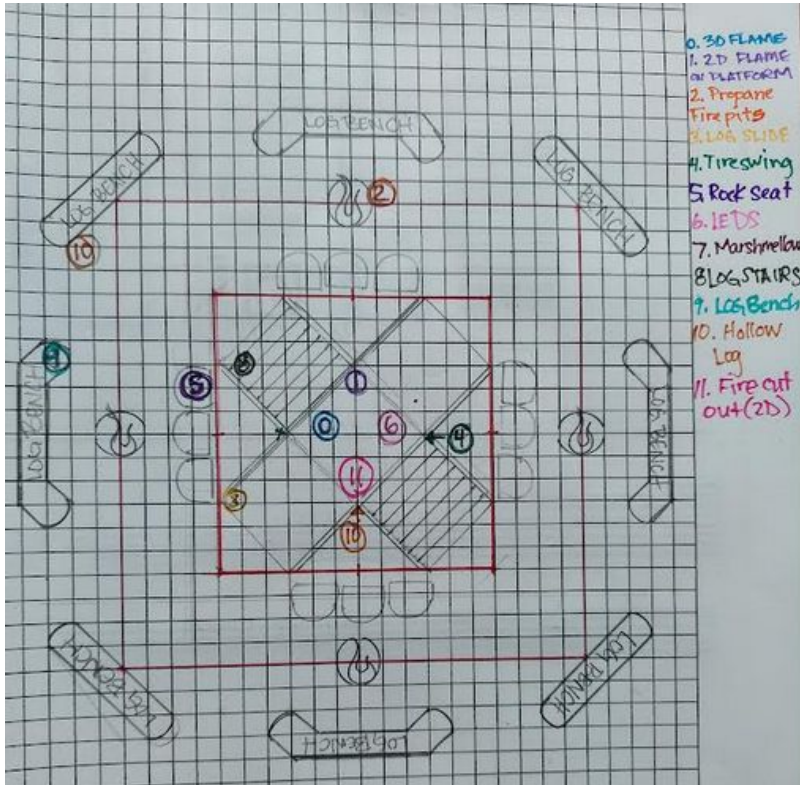



## The details

- ◎ Climbable 3D Flame & 2D Flames
- ◎ Propane Fire pits
- ◎ Hollow Log, Slide, Stairs, & Benches
- ◎ Tire Swing
- ◎ Rock Seats
- ◎ Marshmallows
- ◎ LED Lit Embers & Flame



Help?

- ◎ Location - Burner Barn
- ◎ When - Saturdays afternoon
- ◎ Starting next weekend  
(2/18/23)
- ◎ Leads can volunteer too! 😊

Contact us - [MBS@soakpdx.com](mailto:MBS@soakpdx.com)



Questions?

# Temple of the Sacred Sky

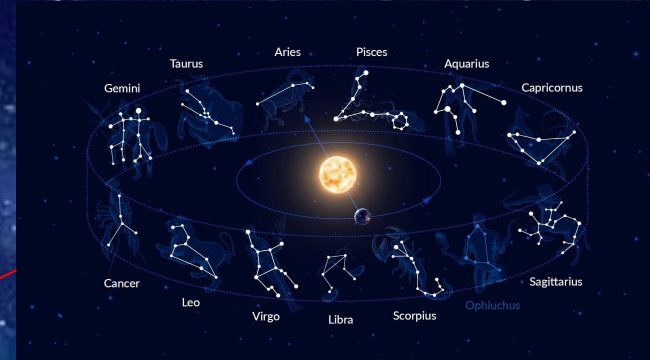
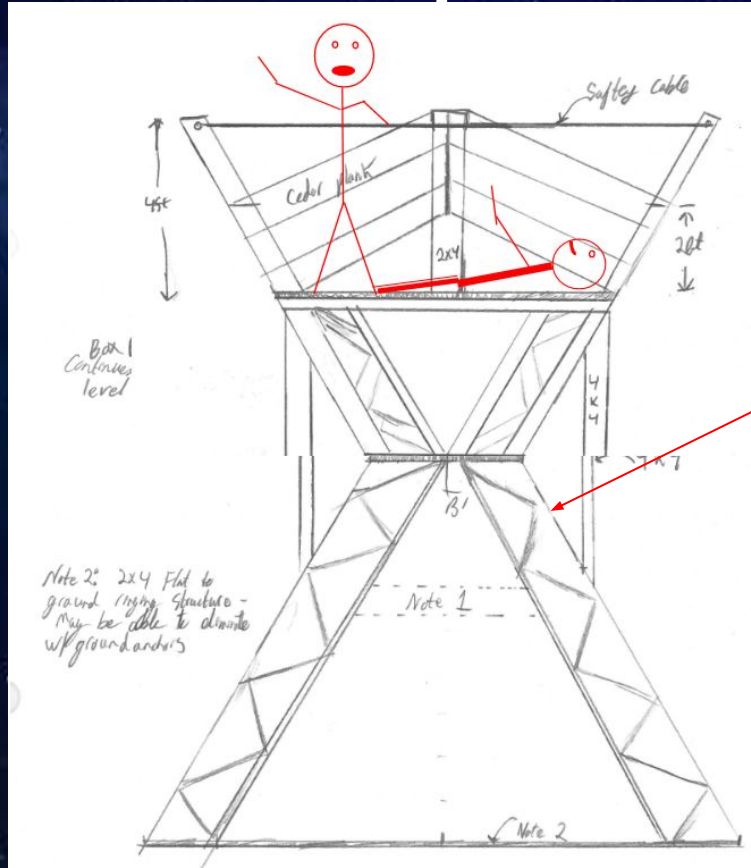

Roof of lower section interior – adorned with constellations





# Temple of the Sacred Sky- Contact

Contact:

Nathan Van Winkle -Lead

nathan.van.winkle@gmail.com

Facebook page:

<https://www.facebook.com/groups/341069489265849>

Discord: <https://discord.gg/S2VRN3PkHA>



# Update: Sanctuary

- Sanctuary Department is sunsetting
- New Medical and Sanctuary vendor: Rock Medicine
- Volunteer Opportunities available!

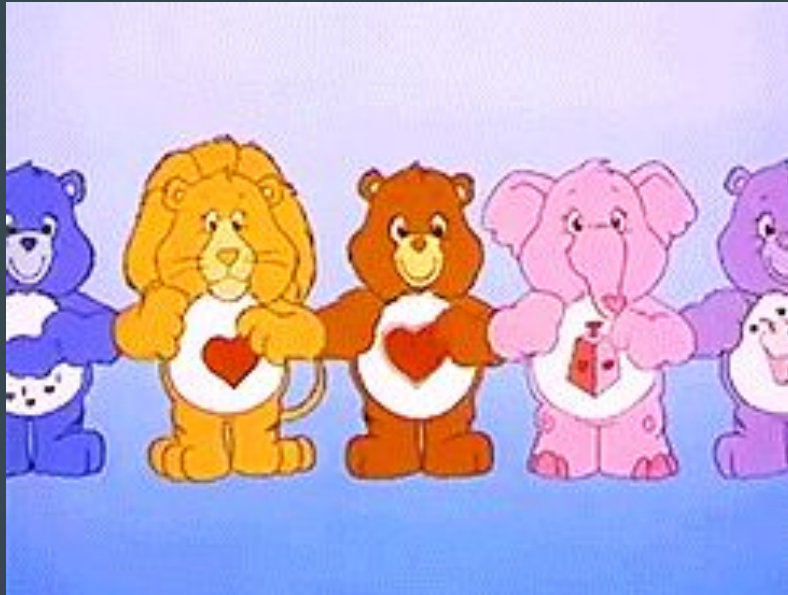

[SOAKpdx.com/blog](https://soakpdx.com/blog)

# New Department: Census



What: Survey participants with questions about themselves, ticket acquisition, culture, etc.

When: As participants arrive

Where: At event arrival, somewhere between box office and parking?!

Why: Describe our population and gain insight into what does and does not work - observe changes over time

# DPW: Seeking co-Lead

- Still seeking a co-Lead



[SOAKpdx.com/blog](https://SOAKpdx.com/blog)

# Covid Policy

- Same as last year
- Must be fully vaccinated as defined by CDC



[soakpdx.com/covid-policy](https://soakpdx.com/covid-policy)



# Sound Policy

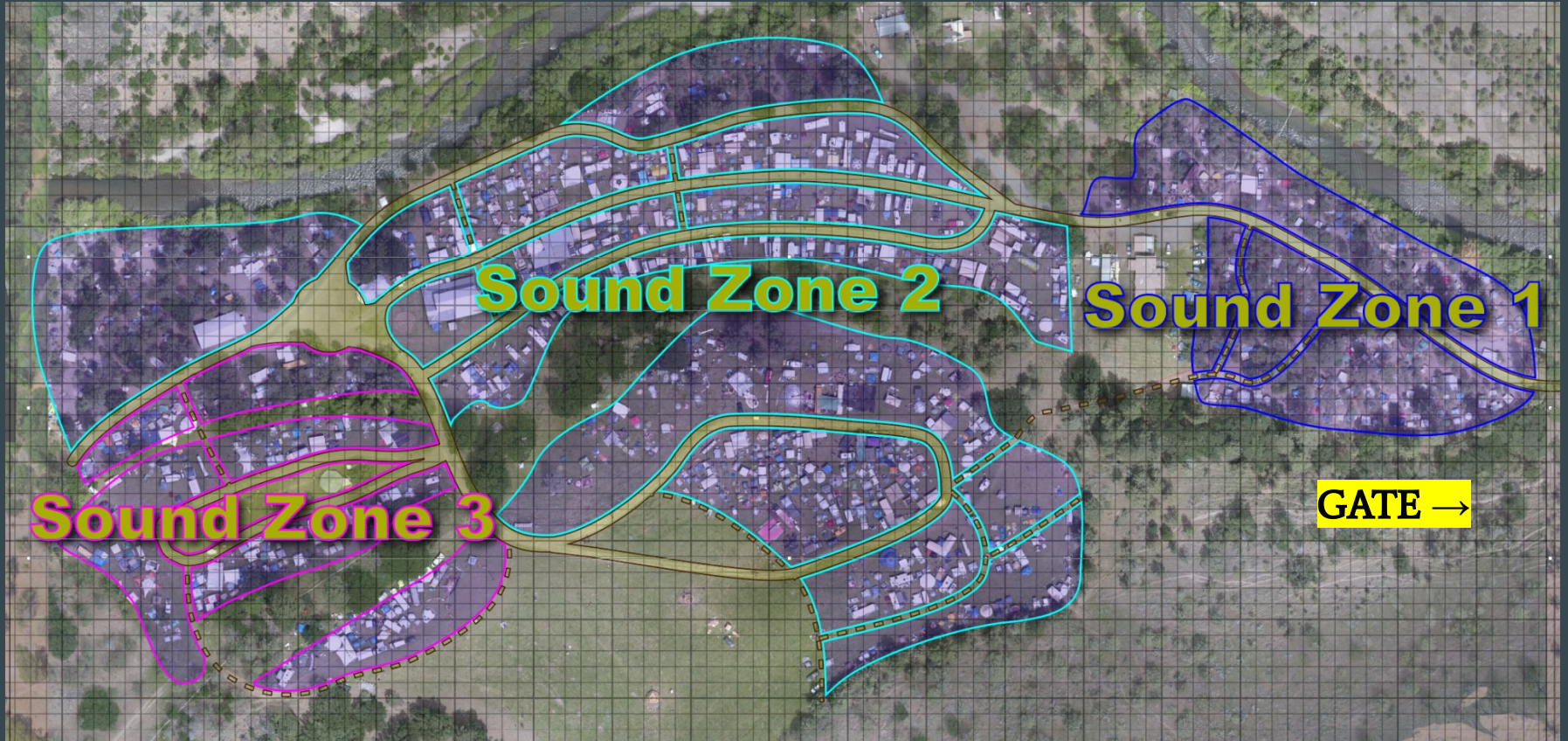

# Tickets!



# Ticket Prices

\$185 Mainsale // \$92.50 subsidized // \$555 Patron

2022	\$169 // \$84.50 subsidized // \$550 Patron
2021	--
2020	--
2019	\$115
2018	\$115
2017	\$110
2016	\$100
2015	\$85, \$115, \$125

# Ticket Allocation



400	vollie, staff, vendors etc
800	artist & theme camp DGS
100	subsidized
20	patron
600	mainsale
100	omg
<hr/>	
<b>2000</b>	<b>total tickets</b>



# Tickets

- Will run through Eventbrite for ease of transfer - this was the deciding factor.
- No more paypal
- Ticket should cost 199.25 after fees
- Recipients of transferred or gift tickets **MUST** claim them through Eventbrite. An email is not enough. No barcode, no entry.

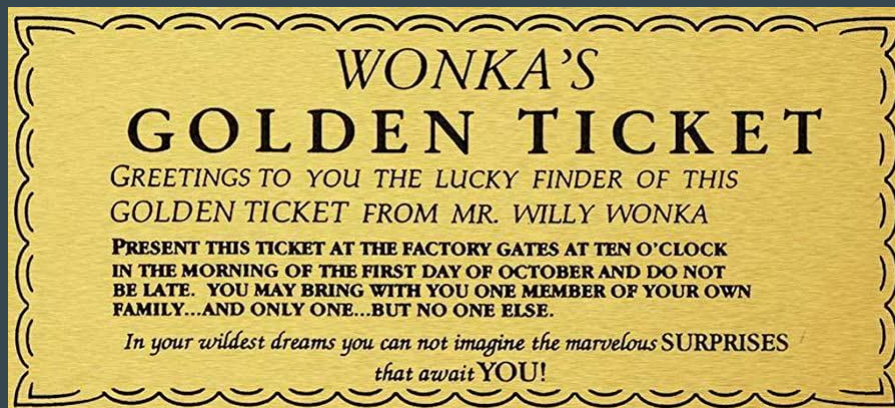

# Ticket Timeline

Patron Tickets	February 24
Volunteer Redemption	March 3
Theme Camp DGS (notified)	March 10
Theme Camp DGS (sale)	March 15
Subsidized Tickets	March 15
Mainsale Tickets	March 22
OMG Sale	May 3

\*Dates subject to change.



# Your Placement Team



Bratty Cat



Cat Lady

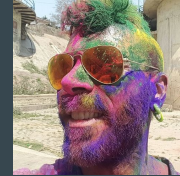

Doggo

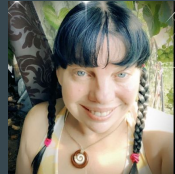

Mishi



Pirate Poppins



Red Wizard



Redirect

# Placement Timeline

**1/30** - Art and Camp Registration opens

**2/15** - Art and Camp Registration soft closes

**2/17** - Hard Close on Camp Registration forms

**2/28** - Art Registration Hard Close

**Mid-February to Early March** - Review Applications

**3/4-3/6** - Map The Event

**3/6** - Placed and Not Placed camps emailed with DGS allocation

**Mid-March** - DGS Sale

**Late March** - Volunteer Signups Open

# Sound Updates

- New Sound Placement Lead - Doggo
  - Focus on resolving historical issues with sound interference
- Establishment of The Harmonic Council of Noise
  - Members: Doggo, and all Camp Sound Leads
  - Pre- and during-event communication, coordination, and cooperation
  - Will be reaching out to Camp Sound Leads after registration closes
  - Will probably involve email threads and Zoom-based conferencing

# On Recreational Vehicles (RVs)

- First-come, first-served for RV General Camping in the SOAK event space.
- Once RV General Camping is full then RVs will only be able to camp in the Overflow Lot located by Gate/Parking.
- If you have an RV, please plan ahead and either arrive early or bring a bike to get back and forth from the Overflow Lot.



# Volunteer!

- Read more at <https://soakpdx.com/volunteer>
- Volunteer registration opens 2/15/23!

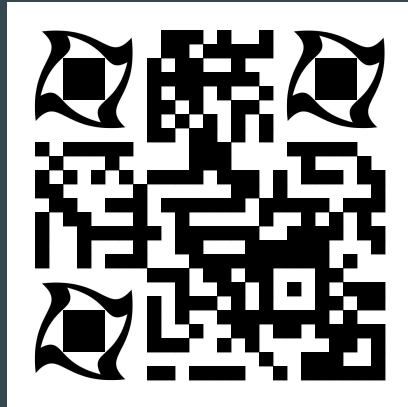

SOAKpdx.com/forms

Questions?





# SAFETY NORTHWEST

APRIL 28-30, 2023

Photo credit Krissy Sorensen



# SAFETY NORTHWEST

- Regional Ranger Training
- Fire Safety Training
- Gate / Parking Training
- Harm Reduction / Sanctuary Training
- Seminar in Emergency Planning for Large Events
- And of course, ICS, Radios, and a Saturday mini Burn!!

Photo Credit Beverly B Drottar



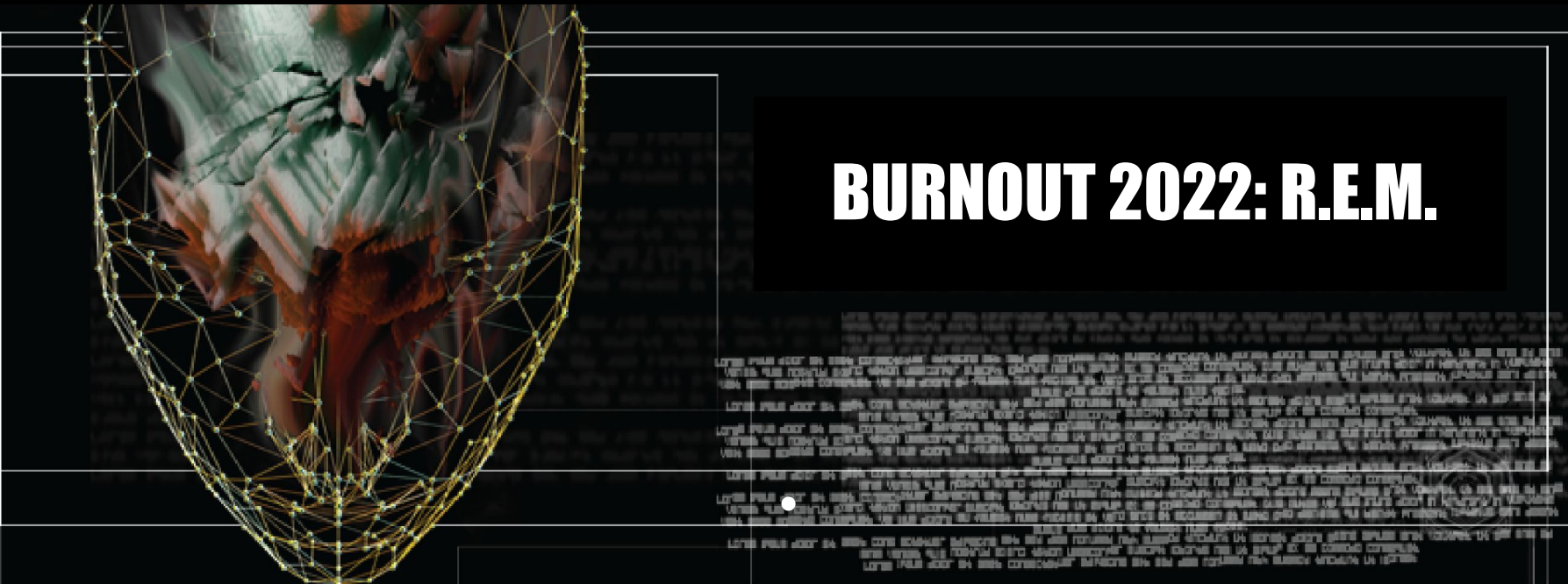

# BURNOUT 2022: R.E.M.

LONE PILE JOCK IN 1994 CONDUCTOR BARBERS HAIR AND TONGUES THE SUICIDE MARCHER IN BURNING JOKES WERE SHOWN THE  
LONE PILE JOCK IN 1994 CONDUCTOR BARBERS HAIR AND TONGUES THE SUICIDE MARCHER IN BURNING JOKES WERE SHOWN THE  
LONE PILE JOCK IN 1994 CONDUCTOR BARBERS HAIR AND TONGUES THE SUICIDE MARCHER IN BURNING JOKES WERE SHOWN THE  
LONE PILE JOCK IN 1994 CONDUCTOR BARBERS HAIR AND TONGUES THE SUICIDE MARCHER IN BURNING JOKES WERE SHOWN THE  
LONE PILE JOCK IN 1994 CONDUCTOR BARBERS HAIR AND TONGUES THE SUICIDE MARCHER IN BURNING JOKES WERE SHOWN THE  
LONE PILE JOCK IN 1994 CONDUCTOR BARBERS HAIR AND TONGUES THE SUICIDE MARCHER IN BURNING JOKES WERE SHOWN THE



# After a 2 year hiatus, Burnout returned with a boom, bringing together:

- 60 volunteers
- 10 Art installations
- 26 DJs
- 75 fire spinners
- 9 live painters
- 700 beautiful participants



**To create a night that's hard to forget and even harder to remember.**

A vibrant laser light show in a dark space, likely a club or event venue. The scene is filled with a dense array of colorful laser beams in shades of blue, purple, red, and yellow, creating a complex geometric pattern of light. In the foreground, the silhouettes of a crowd of people are visible, looking towards the light display. The overall atmosphere is energetic and celebratory.

Thank you so much to everyone that came out and made BurnOut 2022 as amazing as it was.

We're looking forward to Co:Creating another amazing event in 2023 and are excited to announce that we will be offering an Art Grant Program to fund new Art Installations for Burnout and Beyond!

# It was better **THIS** year

Any Questions?



# Stretch Break (let's say a soft 15)

Stretch/smoke/chug/huff/munch 'em if you got 'em



**SOAK\*2023:  
Summer Camp**



**2023 Artist & Civic Provisions**



# Artist Provisions 🔥 What is eligible?



Independently placed Art

New 2D/3D, Sculpture, Mutant Vehicles, Installations, Processions, Projections & other art forms

Interactive, visually intriguing Pacific Northwest Art

New Fire Art\*

\* For fuel assistance, apply for a Civic Provision

Repairs on completed Art

Travel funds for completed projects (Not limited to Pacific Northwest)

Art that aligns with the 10 Principles

**NEW!** “Rental” art MAY be considered if budget allows



# Not Eligible

Tickets  =

Camp labors of love

Theme Camps, Theme Camp décor or Camp

related performance or chill space 

Department projects (ask your producer/director)

Incomplete projects

from outside the Pacific Northwest

Travel funds for incomplete Projects





# Required for applying?



- Visuals of proposed project (Drawings, cad imagery, photographs etc. NO PDF)
- Projects must apply for relevant Placement
- A Budget spreadsheet when asking for over \$100



Application deadline  February 27, 11:59pm

For details

<https://www.soakpdx.com/artist-provisions>

Incomplete applications will not be considered.



# Civic Provisions 🔥 What gets funded?



Fuel for Completed Fire projects that provide functional and/or aesthetic warmth to Participants

Theme Camp Frontage Decoration (Signage, lighting, creative camp boundary markers, fabric to throw over RVs or carports)

Projects that assist the SOAK community, at large, on site  
Examples: Porta Potty Project, which decorates the portos for All. Yellow bikes, which provides bikes for use at SOAK.



# What doesn't get funded

Theme Camp swag, events or things that primarily benefit a particular camp's members 🎪

Travel funds

Tickets 🎫

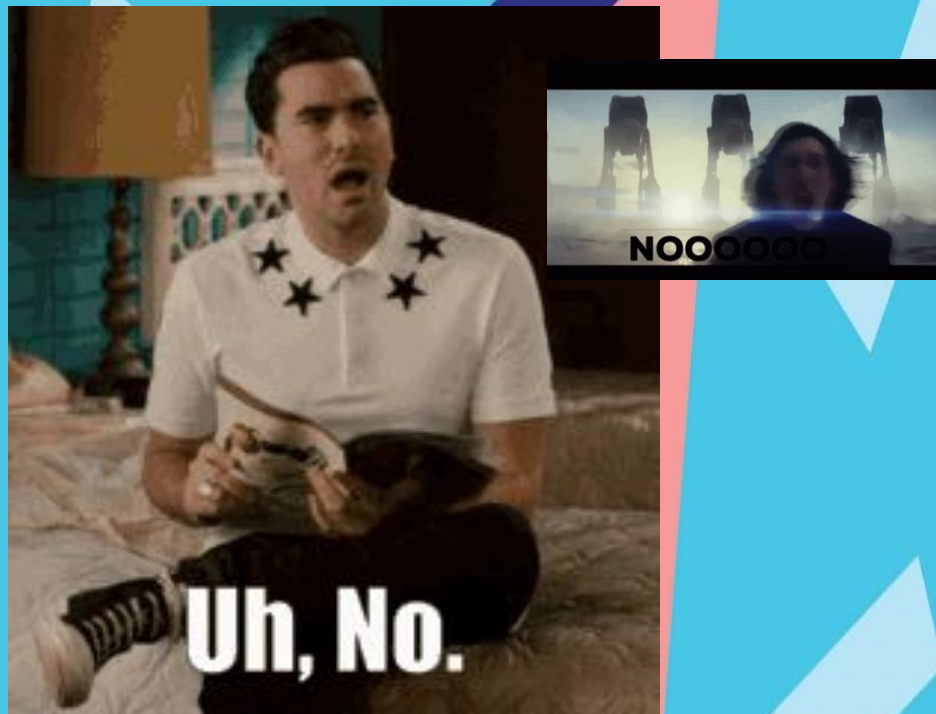

## 👏👏👏 Required for applying? 👏👏👏

- Civic Provisions are generally smaller grants, between \$50-\$250
- TAG, the volunteer Peer Review team, can challenge guidelines, on a case by case basis
- TAG appreciates **concise** details
- One proposal per camp

Application deadline 🔥 February 27, 11:59pm  
Incomplete applications will not be considered.





# Which Provision do I apply to?



**Camp example:** The Tectonic volcano, when placed with Tectonic the Theme Camp, is an aesthetic structure made by humyns that houses dancers, DJs, performance & fire poofs. The metal mountains support the camp's infrastructure, carry the camp's theme and, while the space is shared with Participants, it is generally a space that exists to house the camp's intent. The volcano is Art that directly relates to the camp. Tectonic is eligible for **Community Provisions**.



**Art example:** If the volcano itself was placed independently, without the theme camp nearby, TAG might consider it Independent Art. On it's own, the volcano is not supporting the camp or scheduled for 100%-ish camp use but instead, is standing tall, lookin' pretty, & could be shared with the community to house workshops, events, & whoever comes to play with the Art. In this way, the volcano could be eligible for **Artist Provisions**.

**\*Please note, the volcano is Art at all times. *It is eligible for Artist Provisions only when placed independently.***



Provisions **deadline** 🔥 February 27, 11:59pm

Incomplete applications will not be considered



Questions: [provisions@precipitationnw.org](mailto:provisions@precipitationnw.org)





# Talented And Gifted 🔥 Peer Review

TAG is the volunteer team that helps choose projects to fund.  
Love Art enough to battle over it? Have opinions on Community need?

TAG-You're it! 🔥 Join Peer Review!

Civic applicants can be on TAG for Art review & artists can participate in  
Civic review.

We distance-review Early March





**CREATE**



**IT'S TIME FOR BURNING MAN.**





Precipitation  
NORTHWEST

# Precipitation Northwest Update

# Our Mission



Precipitation Northwest's mission is to **foster opportunities for participatory art, civic engagement, and leadership development.**

Our organization seeks to:

- Use the spirit and principles of Burning Man to build bridges between the Burner community and our fellow citizens of the Portland metro area
- Provide opportunities for skill building, arts education, & leadership development by offering participatory, decommodified, and interactive events

# What PNW Does



Precipitation Northwest is the sponsoring organization for SOAK, BurnOut, and Safety Northwest, as well as the leaseholder for the Burner Barn.

- “Manages the money”
- Provides organizational continuity between programs
- Files taxes and other official documents
- Protects the org’s assets (the community)
- Selects Producers to organize and run Events
- Optimizes current org operations
- Plans for the future
- Develops new programs with community input
- Manages technology
- Develops leadership
- Funds art



# 2023 New Board Members



**Liz Pittinos**



**Abigail Alder**



**Suzanne Mehta**

***Treasurer***

# 2023 Returning Board Members



**Michelle David**  
**Star69**

***Co-President***



**Kristin**  
**Stankiewicz**

***Co-President***



**Frank Broyles**  
**Pope Tart**

***Vice President***



# 2023 Returning Board Members



**Dina Moy**



**Patrice Mackey**  
**Chef Juke**



**Krista Basis**

***Secretary***

# 2023 Retiring Board Members



**Molly  
Harpel  
2020-2022**



**Alexander  
LaVake  
2020-2022**



**Danielle  
Parks  
2019-2022**

# A Year In Review: 2022



- After three long years, SOAK\*2022 finally happened, yay!
  - Thanks to 2022 SOAK Producers: OneEye, GoldDust, Rye
    - Thanks to Emeritus Producers HugBoss & Pablovex
  - Returned to the Justesen Ranch
- Also after a hiatus, the return of Burnout!
- Supporting new programs and activities
  - Social Impact Jam, Clothing Swaps, Solar Workshops, BWB events, and whatever great suggestions you may have
  - Email [programs@precipitationnw.org](mailto:programs@precipitationnw.org) to learn more!



Precipitation  
NORTHWEST

# Site Search: A new home for SOAK\*2024 or beyond?

- At least 80 acres of usable event space
- Allows open burning/fire in May
- Relatively flat
- Access/exit road at least 20 ft. wide/13.5 ft tall
- Area for parking 1,000+ cars with 2 lane egress
- Limited sound/noise/visibility to community & neighbors
- Appropriately zoned for recreation, special events, fire
- Access for Emergency Services (Fire, Law Enforcement, Medical)
- Other requirements available upon request

Radical Inclusion means ensuring SOAK access can be available to those who would like to attend.

This involves finding a place where our event can slowly grow.

Suggestions? Email [site@precipitationnw.org](mailto:site@precipitationnw.org)

# Burner Barn at the Pickle Factory



**Precipitation**  
NORTHWEST



866 N Columbia Blvd, Portland, OR 97217

[www.precipitationnw.org/burnerbarn](http://www.precipitationnw.org/burnerbarn)

Email Burner Barn Manager Samuel:  
[burnerbarn@precipitationnw.org](mailto:burnerbarn@precipitationnw.org)

# Burner Barn at the Pickle Factory



Precipitation  
NORTHWEST

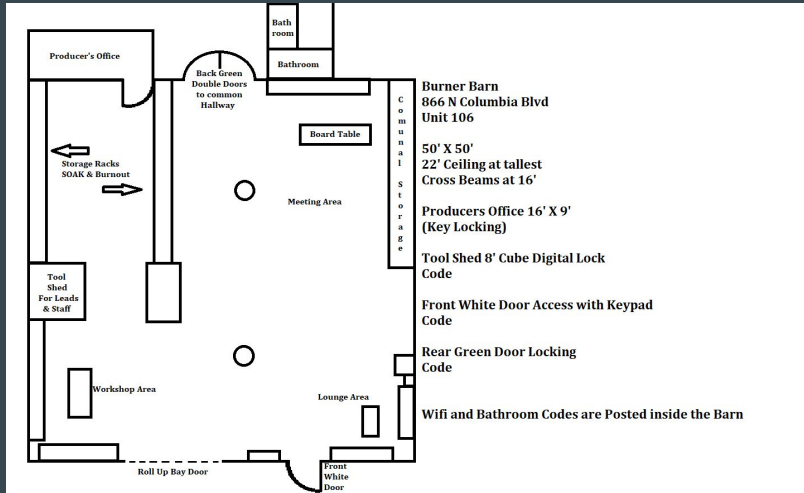

866 N Columbia Blvd, Portland, OR 97217

[www.precipitationnw.org/burnerbarn](http://www.precipitationnw.org/burnerbarn)

Email Burner Barn Manager Samuel:  
[burnerbarn@precipitationnw.org](mailto:burnerbarn@precipitationnw.org)



# Burner Barn at the Pickle Factory



## Event Space Application

The Burner Barn has an open floor plan containing a large table for meetings, a social space with couches and a workshop area with power tools. These spaces are suitable for workshops, meetings, socials or other events that could handle your needs. Please use this form to request access to the space. Usage will be granted based upon the Calendar Availability. Your Request will come confirmed within 48 hours via email.

There is a Blackout Period from the start of March through the end of May for SOAK Planning and Effigy Construction.



## Project Space Application

The form is for Community Members to apply for time and access to the Burner Barn Workshop for Project Usage and Storage. Usage will be granted based upon the Burner Barn Calendar Availability. Your Request will come confirmed within 48 hours via email.

There is a Blackout Period from the start of March through the end of May for SOAK Planning and Effigy Construction.



# Burner Barn at the Pickle Factory



**Parking within the Red Zones only. It has been requested that we not park in front of our space except for loading and unloading.**

866 N Columbia Blvd, Portland, OR  
97217

[www.precipitationnw.org/burnerbarn](http://www.precipitationnw.org/burnerbarn)

Email Burner Barn Manager Samuel:  
[burnerbarn@precipitationnw.org](mailto:burnerbarn@precipitationnw.org)



# Finances

Year	Revenue	Expenses	Net
2020	\$2,964.25	\$70,372.04	-\$67,677.79
2021	\$1,119.44	\$33,830.84	-\$32,711.40
2022	\$286,539	\$194,484	\$92,055

# What's Next: 2023



- More participatory art and ways for the community to engage
- Increased engagement with local organizations
- Increased focus on DEI (Diversity, Equity, and Inclusion) in all activities
- Launch strategic plan & invite community to participate with us



# How To Get Involved

- Join the Board
- Apply to be a SOAK\*2024 Producer
- Submit an Event or Program Idea
- Hold an event at the Burner Barn
- Donate
- Are there other skills you'd like to share with the community?
  - Email us! [board@precipitationnw.org](mailto:board@precipitationnw.org)

# Be Strange, But Not A Stranger!



Email us anytime with ideas, questions, and concerns:

[board@precipitationnw.org](mailto:board@precipitationnw.org)

Visit our website for the most recent news:

[www.PrecipitationNW.org](http://www.PrecipitationNW.org)



Follow us on Facebook:

[www.facebook.com/PrecipitationNW](https://www.facebook.com/PrecipitationNW)

# Regional Contact Update

# Questions

You have questions

We have questions

The Future ??

Town Hall Format ??



# Ways to connect

Email: [Portland@BurningMan.org](mailto:Portland@BurningMan.org)

[www.burningmanportland.com](http://www.burningmanportland.com)

*“Portland-Announce”* email list

Facebook ...

Burning Man Portland

Portland Burners group

Bacon

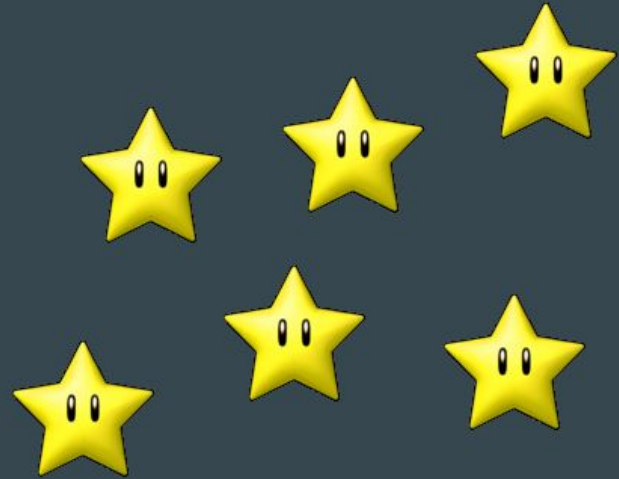

**Ways to connect with  
community before  
SOAK**



# Black Rock Boutique - White Out

Join Black Rock Boutique for our annual fund and long time Portland tradition, Whiteout!

<https://www.facebook.com/events/847347699806957>



# Black Rock Boutique - Clothing Swaps @ Burner Barn

The Boutique is hosting another community clothing swap!

<https://www.facebook.com/events/684345673422409>



# Community Supported Brewing Fundraiser

Feb 24th @ Watershed

Music, drinks, snacks!

**FRIDAY**  
**FEBRUARY 24, 2023**  
**DANCE PARTY 8PM TIL LATE**  
\$25 EARLY BIRD/MORE AT THE DOOR

JIBARO /SIREN PROJECT NYC  
ROB RESONATE  
CLAUDIA MARTINEZ/BROAD BEATS  
MS. MATCH/NATIVE HABITAT  
JEN JIGGEDY/BUNYIP RENEGADES  
DRINKS AND SNACKS PROVIDED

**CSB**  
**2023 CAMP FUNDRAISER**  
**THIRST TRAP**



**RIDE THE BUS  
BRING A CUP**

**THE WATERSHED**  
5040 SE MILWAUKIE AVE/PORTLAND OR 97202  
21 AND OVER

PROOF OF VAX OR NEGATIVE COVID  
AND  
CONSENT & AGREEMENT TO ENFORCED COC REQUIRED

# Cats in Space Fundraiser

Flow Night Takeover. LED and fire Jam, cats in space edition

Raffle with Cat-made goods, lessons, and more • Food and drink services available • Curated music lineup and special guests

A promotional poster for the 'Cats in Space Camp Fundraiser'. The top half features the event title in a stylized, white, outlined font with a decorative flourish underneath, set against a background of pink and purple geometric shapes. The bottom half is dark purple and features the price '\$15' in large white text, the date 'WEDNESDAY MARCH 22, 2023', the location '@ JAJAPDX 819 SE TAYLOR ST, PORTLAND, OR 97214', and the time '6PM-MIDNIGHT'. On the right side, there is a glowing, neon-style illustration of a cat's head with a ringed planet around it, and the text 'CATS IN SPACE' written in a curved, glowing font below it.

**CATS IN SPACE  
CAMP FUNDRAISER**

**\$15**

WEDNESDAY MARCH 22, 2023  
@ JAJAPDX 819 SE TAYLOR ST, PORTLAND, OR 97214  
6PM-MIDNIGHT

CATS IN SPACE

# Social Impact Jam



Social Impact Jam 9/3/2021 - live painting by Simran Gleason

Monthly events with  
live art & nourishment

- Volunteer
- Connect
- Dance
- Celebrate

Earth Day: Beach Cleanup  
Saturday 4/22/23  
Kelly Point Park  
12 - 3 pm



<https://events.eco-munity.com>

**Thanks for attending!**



**2023 TOWN HALL MEETING**